



Leica DM IL LED

Brilliant Optics Combined with Innovative Illumination

The New Inverted Microscope for Routine and Laboratory Microscopy
in Cell Biology and Medicine

Living up to Life

Leica
MICROSYSTEMS

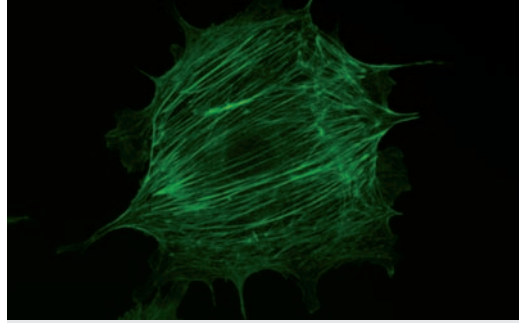

Inverted Routine Microscopy in a New Light

Compact and stable

- Lean and sturdy design
- Plenty of space for operation
- Low stage height
- Large dimensions and low center of gravity of microscope
- Large working distances

Wide variety of possible applications

- Cell biology and medicine
- Micromanipulation (injection, IVF, ICSI)
- Medicine
- Biotechnology
- Developmental biology
- Transgenics
- Molecular biology
- Fluorescence applications

Optical performance and illumination are key elements in microscopy. Both characteristics are unified in the new design of the Leica DM IL LED. As the first inverted routine microscope, the Leica DM IL LED is not only equipped with outstanding Leica HC optics, but also features innovative LED illumination. The transmitted-light illuminator including optimized condensers and improved contrast methods are adapted specifically for cell biology applications. High stability, plenty of space for operation, large working distances, illumination without heat development and the separately accommodated electronics provide optimum conditions for microscopy. The Leica DM IL LED is exceptionally well-suited for uses ranging from various cell and tissue culture examinations in life sciences, developmental biology studies or micromanipulation in cell biology to living cell examinations in transgenics or electrophysiology.



The fluorescence version, the Leica DM IL LED Fluo, also offers a variety of possible applications. Optionally, it is also available with the new LED illumination.

Heatable microscope stages and 3-plate cross-stages provide great flexibility for experiments on living cells under physiological conditions.

The Leica DM IL LED has a further advantage that distinguishes it from other microscopes in its class: The stand is highly compatible with components of the Leica research microscopes. Objectives, eyepieces, tubes, camera ports, contrast methods. Additionally, special tubes and condensers have been developed for the Leica DM IL LED.

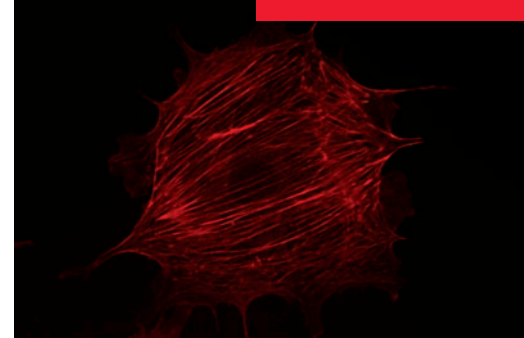

Integrated fluorescence

- Manual fluorescence with three filter cubes
- Integrated shutter
- Optionally LED, classic mercury illumination or fiber optic coupling

Flexible and modular

- A full range of optical components
- Compatible with research stands
- Unheated and heated stages
- Large selection of tubes
- Comprehensive range of accessories for special applications

The Most Comprehensive Array of Contrast Methods

All available contrast methods can be adapted to individual applications easily and quickly. Two condensers have been developed specifically for the Leica DM IL LED, which can be used for the entire magnification range of the respective contrast method. The high-resolution S40/0.45 condenser makes even tiny details of a specimen visible. Both condensers, the S40/0.45 and S80/0.30, allow for use of phase contrast up to the 63x objective as well as Integrated Modulation Contrast (IMC) up to the 40x objective.



Fatigue-free operation

The ergonomic arrangement of all controls such as the focus dial, brightness controller, condenser height adjustment, objective nosepiece and XY stage adjustment allow users to be relaxed while working with the microscope – even for hours. The height-adjustable stages, Ergo tubes with variable tube height, flexible viewing height, and the interpupillary distance and diopter setting enable each user to configure his or her personal Leica DM IL LED. The large working distances provide sufficient room for large culture flasks, and the unobstructed view of the specimen area facilitates handling more difficult specimens.

Brightfield

All Leica brightfield and phase objectives from 2.5x to 100x can be used for stained specimens. The bright field method can be used even for low magnification levels without condenser. A working distance of 200 mm is realized simply by unscrewing the condenser head.

Phase contrast

Phase contrast is used primarily in live cell microscopy to make structures in unstained specimens visible. Three preadjusted light rings on a slider allow phase contrast for all objectives from 5x to 63x. No readjustment is necessary when changing the objectives. The intelligent LED illumination adjusts the brightness automatically when switching between the phase contrast and brightfield method.

Integrated Modulation Contrast (IMC)

IMC creates relief-type images and has proven to be an alternative to Differential Interference Contrast (DIC), particularly in micromanipulation. The IMC developed by Leica Microsystems does not require special objectives because the IMC modulator is not integrated into the objective, but operated via a separate slider. The IMC illumination slider is encoded and controls the LED illumination. IMC is available for both condensers and for standard 10x, 20x, 32x and 40x objectives.

Fluorescence

Incident-light fluorescence is an integral part of the Leica DM IL LED Fluo microscope variant. The fluorescence slider holds three filter blocks. The transmitted light method and fluorescence can be used simultaneously. This way, object structures can be clearly assigned. Each filter block comprises an optimally matched combination of excitation, reflection and barrier filters. Illumination can be generated via the Leica SFL100 LED illumination, the classic mercury illumination or the Leica EL6000 fiber optic coupling.

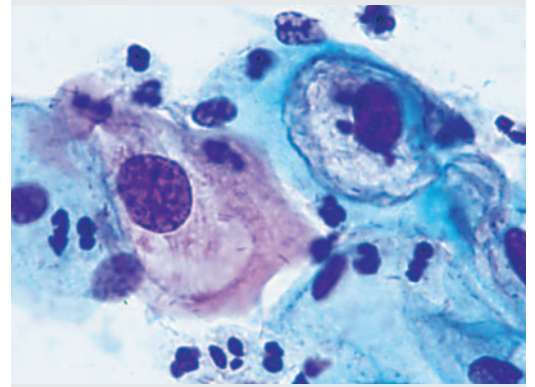

PAP smear, Brightfield

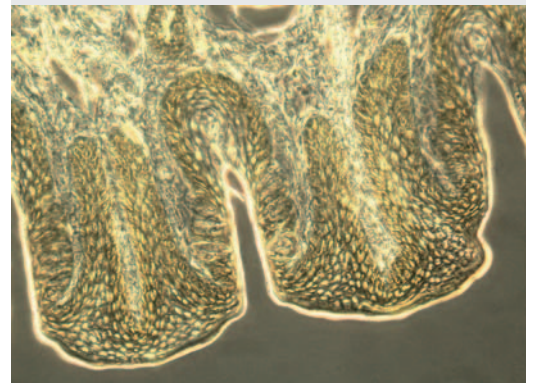

Section taste buds rabbit, Phase Contrast



C. elegans, Integrated Modulation Contrast (IMC)

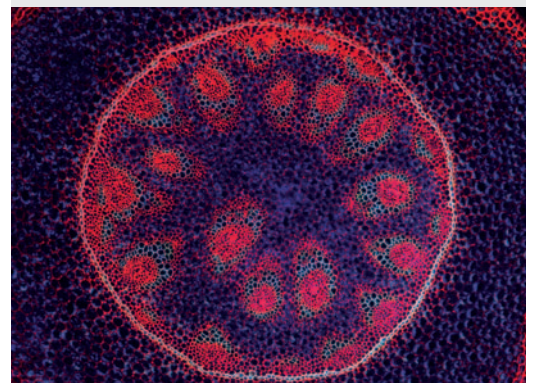

Convallaria lily of the valley, 10x, Fluorescence

Perfectly Illuminated

High-intensity and high-contrast

- 5 watt LED illumination
- Constant color temperature
- Automatic brightness adjustment to the contrast method
- Phase contrast from 5x to 63x
- Modulation contrast for 10x, 20x, 32x and 40x
- Integrated modulation contrast
- Without special objectives; for all condensers

Cost-effective and efficient

- Low energy consumption
- No heat buildup
- LED with a service life of 50,000 hours
- "Auto-off" function for illumination

The Leica DM IL LED is the first inverted routine microscope with LED illumination for the transmitted-light method. The compact illumination unit includes a precentered light emitting diode that has a service life of 50,000 hours.

The LED, with a service life at least 250 times longer than that of conventional halogen lamps, is easy to maintain and very cost-effective. The 5 watt power of the LED is completely converted into light while maintaining uniform color temperature. Nearly no unwanted heat is generated. Optionally, users can activate the integrated automatic shut off – an additional contribution to energy savings.

In particular the phase contrast and IMC are optimized by the warm hue of the LED. With the help of the attachable filter, the illumination impression can be individually adapted in both directions of the color spectrum.

The integrated collector attains optimum light utilization and the integrated aperture diaphragm creates optimum contrast and resolution for every specimen and every objective.

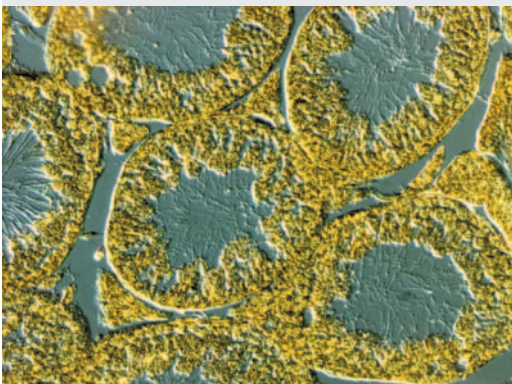

Rat testes, Integrated Modulation Contrast (IMC)



Anything Goes

For the first time, a condenser concept has been realized in the Leica DM IL LED that allows all contrast methods with all condensers. With a working distance of at least 40 mm and a numerical aperture of 0.45, the S40 condenser is the perfect tool for applications for which optimum resolution is the most important parameter. Phase contrast and IMC ensure optimum contrasting.

The working distance of at least 80 mm and 0.30 aperture of the S80 condenser are the ideal prerequisites for achieving maximum possible free room around the specimen and optimum contrasting at the same time. The continuous adjustment of the condenser height depending on specimen vessel and liquid layer is a one-of-a-kind feature. It ensures maximum flexibility when using peripheral microtools.

Whether you work with thin sections or thick specimens, phase and modulation contrast produce a brilliant microscopic image for all specimens and applications.



Perfect for your applications – the S40 and S80 condensers



High-intensity and high-contrast – the 10 W LED illumination



Flexible Fluorescence



Innovative LED illumination for fluorescence applications with the Leica SFL100.

Fluorescence applications, in particular GFP labeling, play an ever more important role in clinical diagnostics and routine microscopy. The Leica DM IL LED Fluo has been designed in consideration of this trend. The microscope has been equipped with a fluorescence axis and a 3-position slider to ensure fast and easy switching to different fluorochromes. The slider glides smoothly in an elaborately constructed dovetail guide. An extensive, constantly growing range of filters allows a wide variety of fluorescence examinations. The filter blocks are optimized for minimizing stray light. Excitation, reflection and barrier filters adapt to your application. Transmitted-light methods can be used simultaneously or as an alternative so that fluorescent and nonfluorescent structures can be clearly assigned. An integrated shutter protects the specimen against bleaching.

The Leica DM IL LED Fluo is the first routine fluorescence microscope that allows users to choose between classic illumination (halogen, mercury or high-pressure xenon lamps), the "cold" light guide coupling of the Leica EL6000 and the new LED illumination, Leica SFL100. This gives users the ability to excite and examine fluorochromes to see more detail under the microscope. A dark background and the bright emitted fluorescence produce brilliant color images. The field of applications ranges from DAPI (UV) for nuclear staining to CY5 (IR) for immunohistochemical arrays. The Leica DM IL LED Fluo thus is a high-performance instrument for use in immunology, cytology, virology – and in any field that requires fluorescence techniques for living specimens.



Leica DM IL LED with fluorescence axis and 3-position slider

Capturing Every Detail

A large selection of tubes is available for the Leica DM IL LED. All tubes can be rotated individually by 360° and are equipped with a 1x tube lens and an eyepiece holder for HC optics.

In addition, two special tubes have been developed for the Leica DM IL LED:

- ILB binocular tube with a viewing angle of 45°
- ILT trinocular tube with a viewing angle of 45° and vertical camera port with selectable light path (100% photo or 100% visual). The port is positioned 88 mm to the side and allows an unobstructed view of the specimen at all times. It is also possible to center the camera port.

Nine other tubes from the range of accessories for upright Leica microscopes are also available. These include different tubes with fixed viewing angles and Ergo tubes with variable viewing angles, Ergo tubes with camera port and different splittings of the light path.

Apart from the Ergo Modules for variable height adjustment, Leica Microsystems offers a drawing attachment for special examinations and a discussion attachment for two observers.

A large selection of TV adapters is available for a wide variety of camera types. Leica digital cameras offer many advantages for live cell microscopy. The product range includes everything from color cameras for various applications to monochrome camera systems for fluorescence applications. Leica digital cameras offer variable resolutions for live imaging; Resolutions range between 1.3 and 12 megapixels at a color depth of up to 14 bits per color channel.



Leica DM IL LED with trinocular tube for transmitted-light applications



Discussion attachment for two observers on the Leica DM IL LED

Properly Cultured



Heating insert for Petri dishes



TempControl 37 for Leica DM IL LED stands with heating stage



In live cell microscopy, the right microscope stage and the corresponding accessories are important prerequisites for the best results. In addition to the fixed stages with or without mechanical stage, Leica Microsystems offers 3-plate cross-stages with different inserts for a wide variety of culture flasks. All microscopes are also available with heating stages or heating inserts. The sturdy mechanical system and the compact stand ensure best possible stability.

Leica DM IL LED	
Optics	Infinity corrected (HCS), tube factor 1x
Field of view	20 mm
Lamp power supply	External power supply AC input: 100-240 V 0.33-0.19 A DC output: 5 V $\overline{\text{---}}$ 2 A
Illumination	5 watt LED
Focusing	Coarse and fine adjustment, nosepiece focusing, vertical travel 7 mm
Objective Nose-piece	4-position, M25x0.75 objective thread
Stage	Fixed work stage with 3-point support 248 x 212 x 20 mm or Heating stage 248 x 212 x 20 mm incl. TempControl 37 or 3-plate stage, 150 x 150 mm insert plate, adjustment range 60 x 40 mm
Transmitted-light illuminator arm	with illumination unit, with precentered LED illumination incl. collector, diffusion filter, iris aperture diaphragm, condenser holder
Additionally for fluorescence versions:	
Lamp housing	Interchangeable lamp housings for fluorescence
Fluorescence	Integrated lamp mount in a massive, stable back panel, integrated fluorescence axis, 3-position fluorescence slide for three different filter blocks, dark stop

Overview of the Leica DM IL LED

		DM IL LED Fluo	DM IL LED
Optics	Leica HC optics (infinity corrected) HC objectives: 2.5x–100x	●	●
Objective Nosepiece	Four positions	●	●
Focus	Coaxial coarse and fine adjustment, travel path 7 mm, nosepiece focusing	●	●
Transmitted-light illuminator	5 watt LED, external power supply (in 100-240, out 5 V/2 A) Filter holder for TL filter Ø 32 mm, collector, scattering filter	●	●
Condenser	Interchangeable condenser heads: S40/0.45: available working distance 40 mm, aperture 0.45 S80/0.30: available working distance 80 mm, aperture 0.30	●	●
Contrasting	Precentered insert with four positions (Brightfield, 5x–63 x Phase Contrast) Insert for IMC illumination (Brightfield, 10x, 20x, 32x, 60x IMC)	●	●
Contrast methods	Brightfield, Phase Contrast, Integrated Modulation Contrast	●	●
Fluorescence	Fluorescence slider with three positions for filter cubes Manual light stop	●	—
Fluorescence illumination	Fluorescence LED Leica SFL100, 50 W Hg, 100 W Hg, Leica EL6000 fiber optic coupling	●	—
Stages	Fixed stage, fixed heating stage, 3-plate stage, attachable mechanical stage for both fixed stages	●	●
Documentation	Camera port for all Leica digital cameras and common camera models	●	●
Tubes	– Binocular tube 45°, interpupillary distance 55–75 mm, field of view 20 mm – Trinocular phototube 45°, interpupillary distance 55–75 mm, field of view 20 mm, with camera port positioned 88 mm to the side, selectable 100% photo or 100% visual Additional options in the Leica DM product line: – Standard binocular tube 30°, Ergo binocular tube 15° – Ergo Vario binocular tube 7.5–15°, Ergo Vario binocular tube 0–55° – Ergo Vario binocular tube 5°–32° and eyepiece extension 0–30 mm – Standard trinocular phototube 30°, Ergo Vario trinocular phototube 0°–35°	●	●

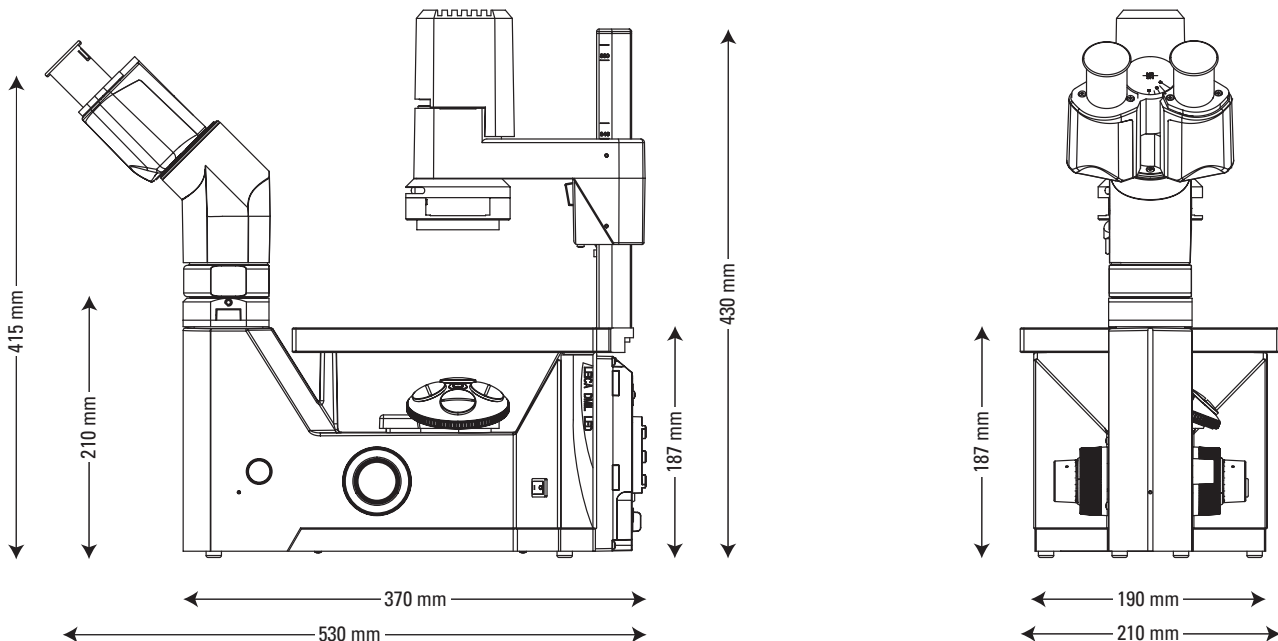

“With the user, for the user”

Leica Microsystems

Leica Microsystems operates globally in four divisions, where we rank with the market leaders.

• Life Science Division

The Leica Microsystems Life Science Division supports the imaging needs of the scientific community with advanced innovation and technical expertise for the visualization, measurement, and analysis of microstructures. Our strong focus on understanding scientific applications puts Leica Microsystems' customers at the leading edge of science.

• Industry Division

The Leica Microsystems Industry Division's focus is to support customers' pursuit of the highest quality end result. Leica Microsystems provide the best and most innovative imaging systems to see, measure, and analyze the microstructures in routine and research industrial applications, materials science, quality control, forensic science investigation, and educational applications.

• Biosystems Division

The Leica Microsystems Biosystems Division brings histopathology labs and researchers the highest-quality, most comprehensive product range. From patient to pathologist, the range includes the ideal product for each histology step and high-productivity workflow solutions for the entire lab. With complete histology systems featuring innovative automation and Novocastra™ reagents, Leica Microsystems creates better patient care through rapid turnaround, diagnostic confidence, and close customer collaboration.

• Surgical Division

The Leica Microsystems Surgical Division's focus is to partner with and support surgeons and their care of patients with the highest-quality, most innovative surgical microscope technology today and into the future.

The statement by Ernst Leitz in 1907, “with the user, for the user,” describes the fruitful collaboration with end users and driving force of innovation at Leica Microsystems. We have developed five brand values to live up to this tradition: Pioneering, High-end Quality, Team Spirit, Dedication to Science, and Continuous Improvement. For us, living up to these values means: **Living up to Life.**

Active worldwide

Australia:	North Ryde	Tel. +61 2 8870 3500	Fax +61 2 9878 1055
Austria:	Vienna	Tel. +43 1 486 80 50 0	Fax +43 1 486 80 50 30
Belgium:	Groot Bijgaarden	Tel. +32 2 790 98 50	Fax +32 2 790 98 68
Canada:	Richmond Hill/Ontario	Tel. +1 905 762 2000	Fax +1 905 762 8937
Denmark:	Herlev	Tel. +45 4454 0101	Fax +45 4454 0111
France:	Nanterre Cedex	Tel. +33 811 000 664	Fax +33 1 56 05 23 23
Germany:	Wetzlar	Tel. +49 64 41 29 40 00	Fax +49 64 41 29 41 55
Italy:	Milan	Tel. +39 02 574 861	Fax +39 02 574 03392
Japan:	Tokyo	Tel. +81 3 5421 2800	Fax +81 3 5421 2896
Korea:	Seoul	Tel. +82 2 514 65 43	Fax +82 2 514 65 48
Netherlands:	Rijswijk	Tel. +31 70 4132 100	Fax +31 70 4132 109
People's Rep. of China:	Hong Kong	Tel. +852 2564 6699	Fax +852 2564 4163
Portugal:	Lisbon	Tel. +351 21 388 9112	Fax +351 21 385 4668
Singapore		Tel. +65 6779 7823	Fax +65 6773 0628
Spain:	Barcelona	Tel. +34 93 494 95 30	Fax +34 93 494 95 32
Sweden:	Kista	Tel. +46 8 625 45 45	Fax +46 8 625 45 10
Switzerland:	Heerbrugg	Tel. +41 71 726 34 34	Fax +41 71 726 34 44
United Kingdom:	Milton Keynes	Tel. +44 1908 246 246	Fax +44 1908 609 992
USA:	Bannockburn/Illinois	Tel. +1 847 405 0123	Fax +1 847 405 0164

and representatives in more than 100 countries